

Fiche produit

FLEX

Ensemble sur grande plaque Clé I (cylindre européen)

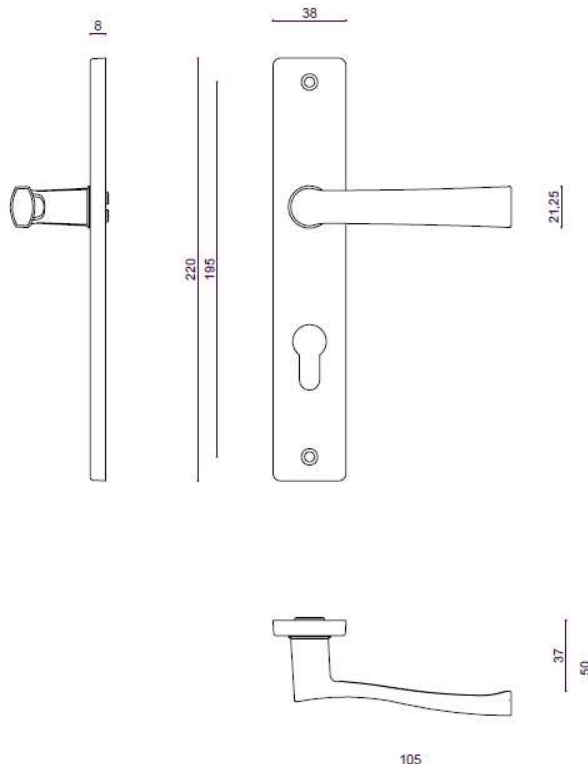

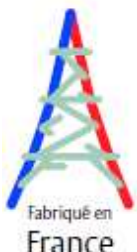







Gamme :

- Version double béquille
- Version grande plaque entraxe 195 mm
- Perçages :
 - Bec de cane
 - **Clé I (cylindre européen)**
 - Clé L
 - Condamnation simple
- Finitions :
 - Chrome satin

Descriptif

- Béquille en zamak
- Ensemble monobloc : béquille et plaque solidarisées
- Ressort de rappel de béquille
- Carré de 7mm
- Vis bouchons
- Vis de fixation M4 entraxe 195mm
- Fixations traversantes incluses pour portes épaisseur 38 à 43 mm
- Livré en standard pour serrure entraxe 70mm

Qualification selon la norme EN1906-2012

							
Catégorie d'utilisation	Endurance	Masse de la porte	Résistance au feu	Sécurité des personnes	Résistance à la corrosion	Sécurité des biens	Type d'opération
1	6	--	B	0	4	0	B



Experience a safer
and more open world