

# Fiche produit

## Kaza

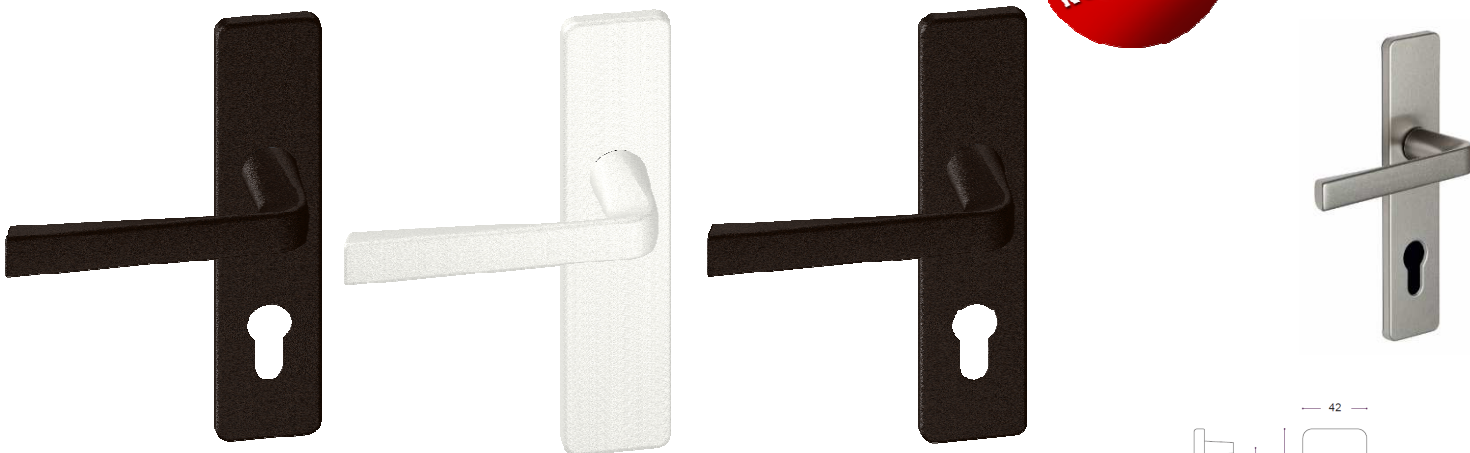



### Ensemble sur petite plaque



#### Gamme :

- Version double béquille ou poignée de tirage côté extérieur
- Version grande ou petite plaque à coins carrés
- Perçages :
  - Clé I
  - Clé L
  - Condamnation simple
  - Condamnation à voyant
  - Bec de cane
  - SGN2

#### Finitions :



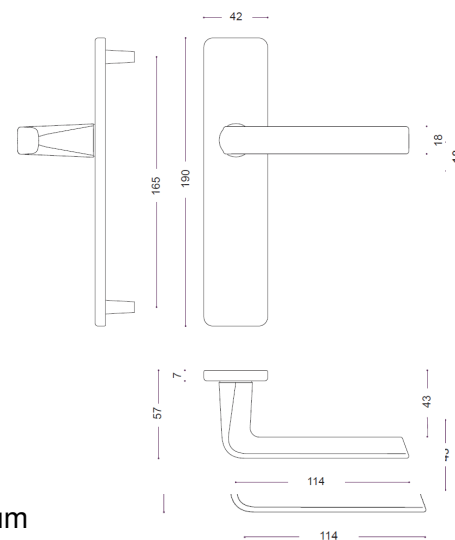





-  - Argent
-  - Anodinox
-  - BASALT : noir mat finement texturé
-  - ALBA : blanc mat finement texturé
-  - SILEX : chocolat mat finement texturé



#### Descriptif technique :

- Béquille en aluminium
- Ensemble monobloc : béquille et plaque solidarisées
- Plaque renforcée avec sous-plaque en polyamide chargé à 60% en fibre de verre
- Piliers taraudés intégrés et vis invisibles côté extérieur
- Carré de 7mm
- Vis de fixation M4 entraxe 165mm

#### Qualification selon la norme EN1906-2012

							
Catégorie d'utilisation	Endurance	Masse de la porte	Résistance au feu	Sécurité des personnes	Résistance à la corrosion	Sécurité des biens	Type d'opération
2	6	--	B	1	4	0	U



ASSA ABLOY, the global leader in door opening solutions\*

\*ASSA ABLOY, le leader mondial des solutions d'ouverture de portes